

FLUX

Multifunctional Flood Light
6W 20W

Installation Manual

SOLTECH Designs and Manufactures
Advanced, Solar-Powered
LED Technology.



SOLTECH
Smart Solar Lighting

01 Introduction

Thank you for purchasing FLUX Multifunctional Flood Light Products.

Important

Please read these instructions before installation to ensure optimum results and longevity of your lights. The solar panel should be charged in full sunlight for 8 to 9 hours before initial first use to provide optimum results.

Features

- Eliminates trenching, cabling, and electricity costs
- Solar panel bracket is 360 degrees adjustable, and the light module is 270 degrees adjustable. Adjusting the solar panel angle maximizes solar energy collection, and allows snow, dirt, and other debris to slide or wash off
- Large battery capacity of 7,680 mAh enables long run times and high light output
- Wall-mounting and post-mounting accessories available
- The latest advanced Li-ion battery lasts 2000+ charging cycles.
- 7 operating modes are programmable via remote control or controls on the fixture
- IP66 rated protection from water, dirt, and dust
- The easiest way to bring lighting to any outdoor application
- Photo and motion sensors, wide angle 360° detection, high sensitivity

Notice & Warning

1. The FLUX will provide optimal performance where there is direct sunshine.
2. Please note the lighting run time depends on sunshine duration and weather.
3. The fixture will turn on automatically at dusk.
4. Built-in intelligent IC provides over-charge, over-discharge, and over-voltage protection.
5. Do not disassemble the fixture.
6. Do not dispose of the battery with household garbage, to avoid explosion.

Please Note

During continuous rainy or cloudy days, run time may be reduced as the battery will not be fully charged.

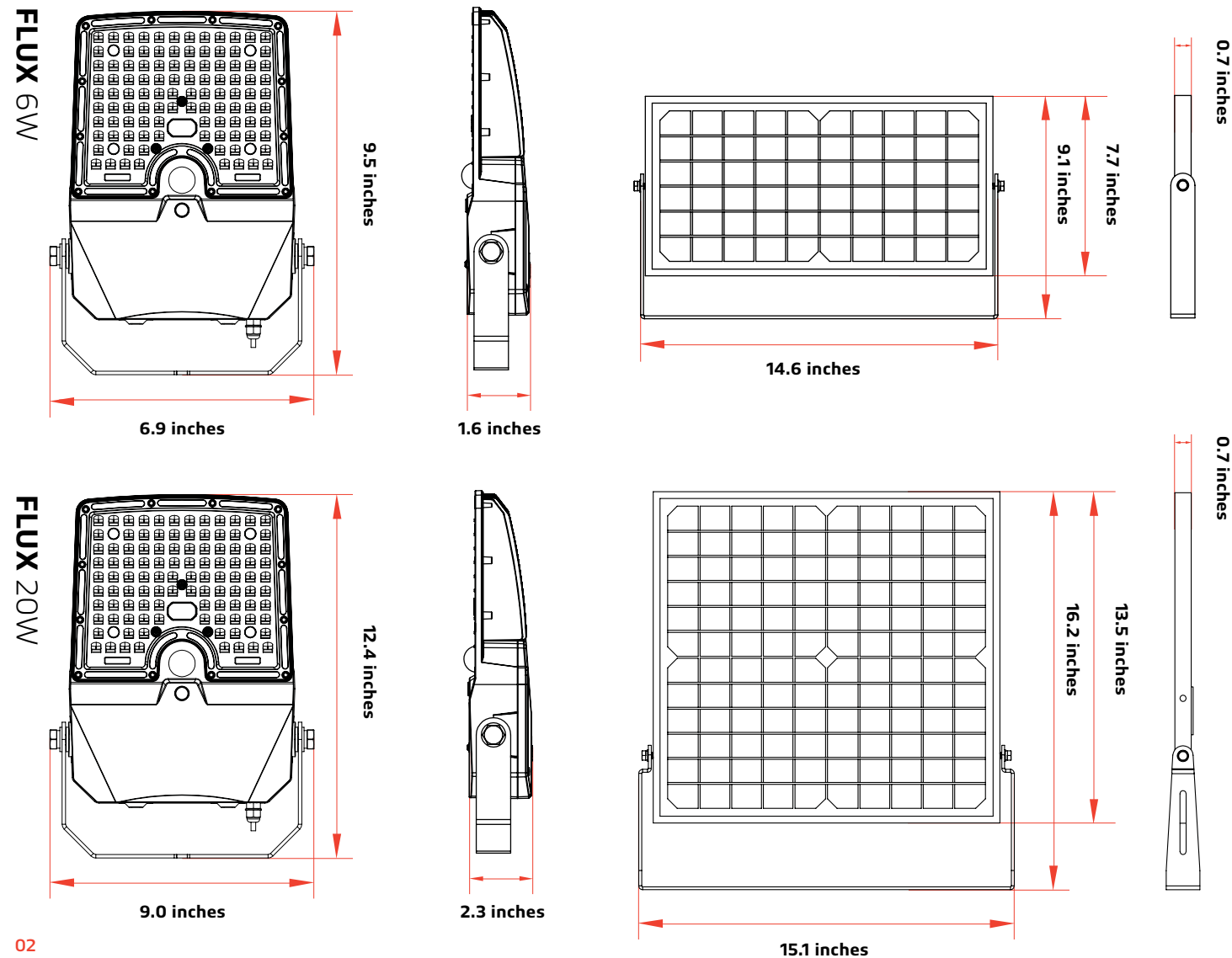

02 Specification

Specifications	FLUX 6W	FLUX 20W
LED Nominal Power	6W	20W
Solar Panel	Mono-Crystalline 10V 10W	Mono-Crystalline 10V 20W
LiFePO ₄ Battery	6.4V 3AH	6.4V 12AH
CCT	4,000K	4,000K
Lumen Output@4000K	1,020	3,400
CRI	> 70	> 70
Product Size	Light Head 9.5 X 6.9 X 1.6 Inches Solar Panel 7.7 X 14.6 X 0.7 Inches	Light Head 12.4 X 9.0 X 2.3 Inches Solar Panel 13.5 X 15.1 X 0.7 Inches
Beam Spread	>130°, NEMA type 7 Very Wide	>130°, NEMA type 7 Very Wide
EPA	1.41	2.51
Cable Length	16.5 ft	16.5 ft
IP Rating	IP66	IP66
Casting	PC & Aluminum	PC & Aluminum
Efficiency@4000K	170 lm/W	170 lm/W
* Charging Time	6hrs (1000W/m ²)	6hrs (1000W/m ²)
Run Time (@Full Charged)	5-7 Rainy Days	5-7 Rainy Days
Operation Mode	7 Operating Modes	7 Operating Modes
PIR Sensor Angle / Distance	360° / 16.4 ft	360° / 16.4 ft
* Operating Temperature	-4 °F to 122 °F	-4 °F to 122 °F
* Charging Temperature	32 °F to 149 °F	32 °F to 149 °F

* The temperature can impact the battery's charge and daily operation.

* The solar charge data is base on 77 degree F ambient temperature with the panel facing direct solar radiation. The standard radiation value is 1000W/m².

03 Installation

WALL MOUNT

01. Permanent Mounting

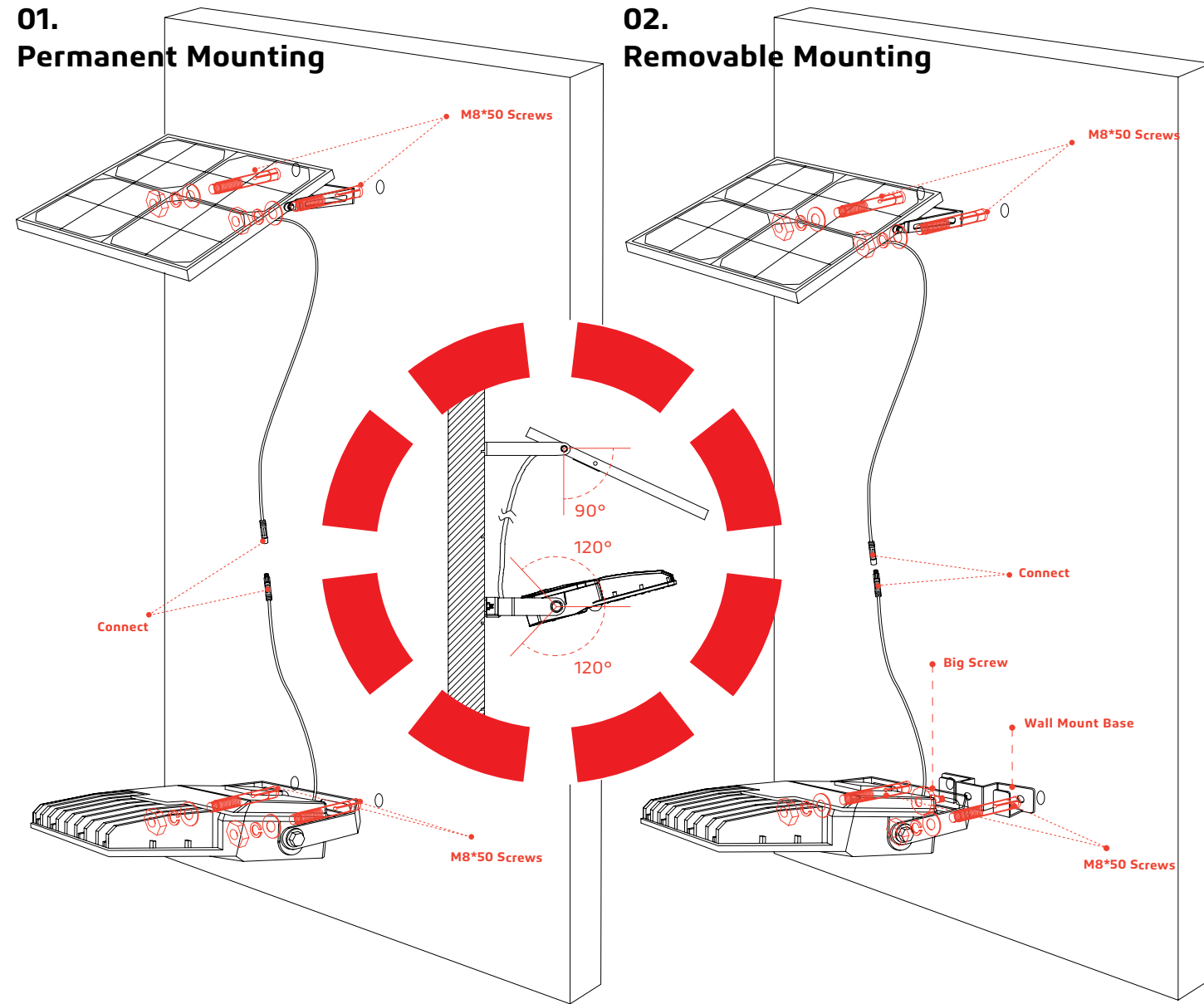

First mount the solar panel:

1. Drill two holes into the wall surface then use the screw kit to secure the solar panel bracket on the wall.
2. After you secure the solar panel bracket, attach the solar panel to the bracket.

Then mount the fixture:

3. Drill two holes into the wall surface. Attach the bracket to the fixture then secure to the wall surface with the screw kit.
4. Connect the light and solar panel cables.

02. Removable Mounting

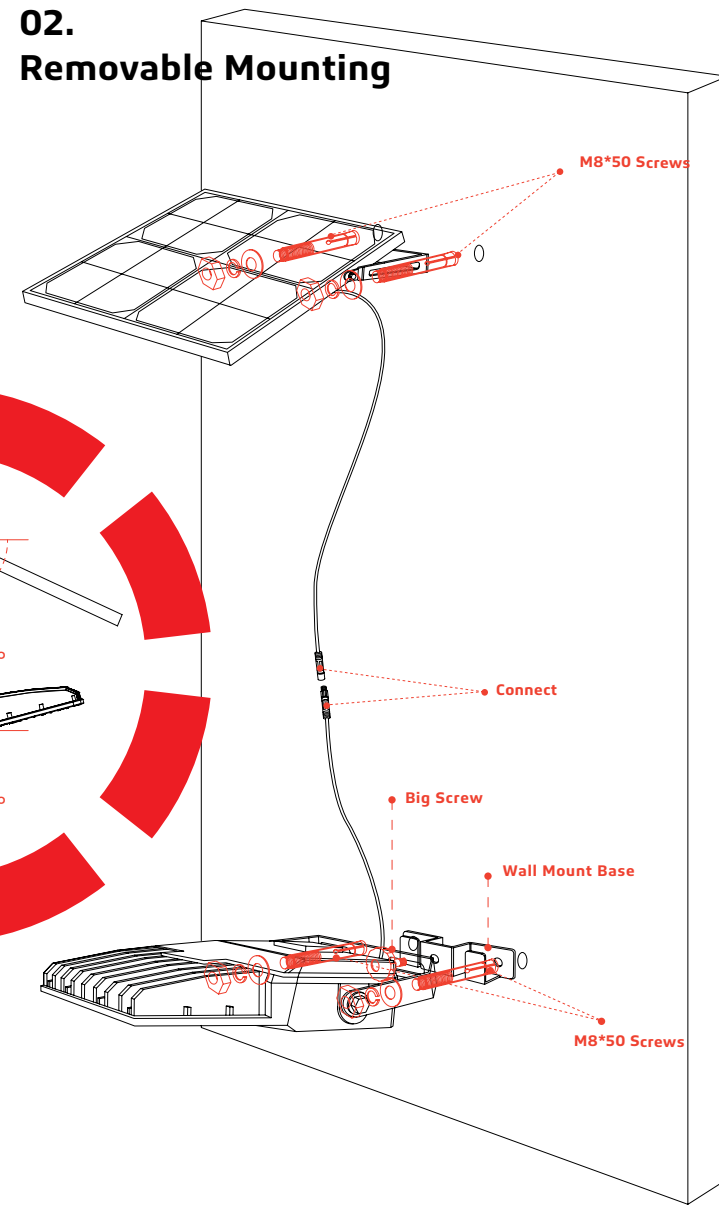

First mount the solar panel:

1. Drill two holes into the wall surface, then use the screw kit to secure the solar panel bracket on the wall.
2. After you secure the solar panel bracket, attach the solar panel to the bracket.

Then mount the fixture:

3. Drill two holes into the wall surface, then screw in the wall mount base to the wall.

4. Attach the bracket to the fixture and then hang the bracket on the wall mount base. Lastly, use the big screw to hold them together.
5. Connect the light and solar panel cables.

POLE MOUNT

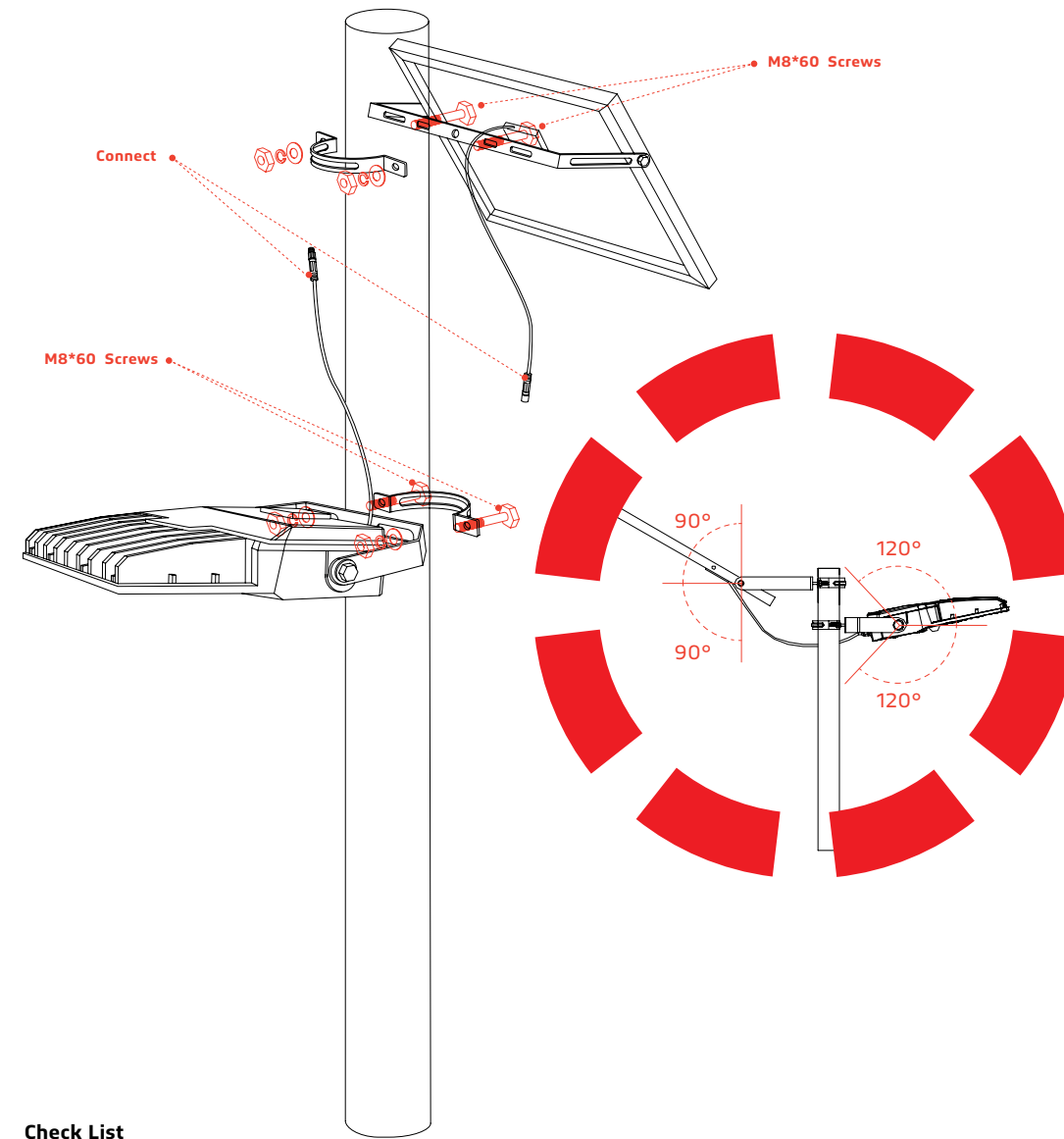

First, mount the solar panel to the pole:

1. Use the screw kit to secure the pole mount base and the solar panel bracket to the pole.
2. Then attach the solar panel to the bracket.

Then, mount the fixture:

3. Attach the bracket to the fixture.
4. Use the screw kit to secure the fixture bracket to the pole mount base on the pole.
5. Connect the light and solar panel cables.

Check List

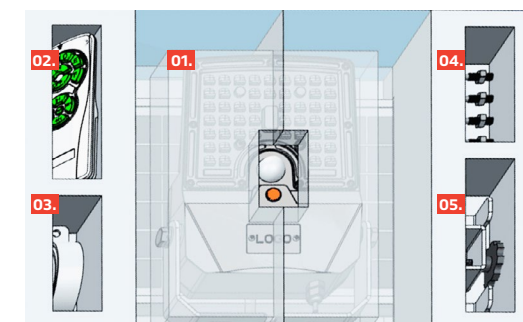

FLUX 6W

- | | |
|--------------------|--------------------------------------|
| 01. Fixture | 03. Pole Mount |
| 02. Remote Control | 04. Screw Kit (M8*60 X 4, M8*50 X 4) |
| | 05. Wall Mount Base |

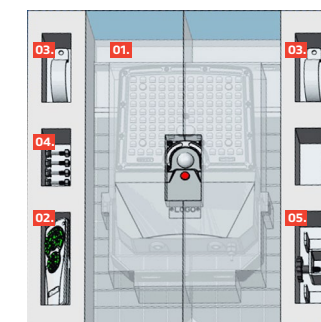

FLUX 20W

- | | |
|--------------------|--------------------------------------|
| 01. Fixture | 03. Pole Mount |
| 02. Remote Control | 04. Screw Kit (M8*60 X 4, M8*50 X 4) |
| | 05. Wall Mount Base |

04 Remote Control

MOTION SENSOR MODES

A Light on 100% if motion is detected, stand-by period is 60 seconds. Light will turn off when no motion is detected.



B Light on 100% if motion is detected, stand-by period is 60 seconds. Light will dim down to 5% output when no motion is detected.



C Light on 100% if motion is detected, stand-by period is 120 seconds. Light will turn off when no motion is detected.

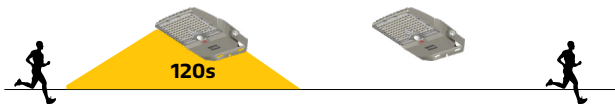

D Light on 100% if motion is detected, stand-by period is 120 seconds. Light will dim down to 5% output when no motion is detected.



REMOTE CONTROL INSTRUCTIONS

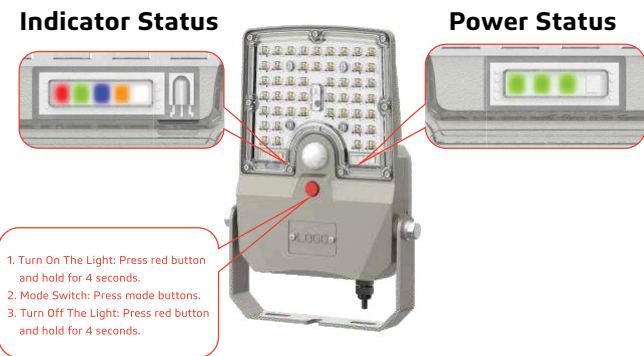

Remote Buttons	Indicator Status
A	Red
B	Green
C	Red+Green
D	Blue
E	Blue+Red
F	Blue+Green

Additional Notes

- The flood lights "Turn On" time depends on the client's local time (Turn-on Light Level:< 20Lux).
- A, B, C, D, E and F modes have memory functions. For example, if you press mode A and then press the OFF button, Mode A will still be activated when you turn the light on again until end user resets the mode.

E Light on 50% for 3 hours (Sensor disabled), then returns to motion sensor mode. If motion detected, stand-by period is 60 seconds. Light will turn off when no motion is detected.

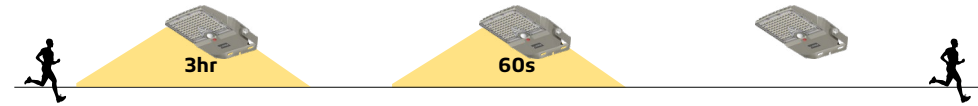

F Light on 50% for 3 hours (Sensor disabled), then returns to motion sensor mode. If motion detected, stand-by period is 60 seconds. Light will dim down to 5% output when no motion is detected.

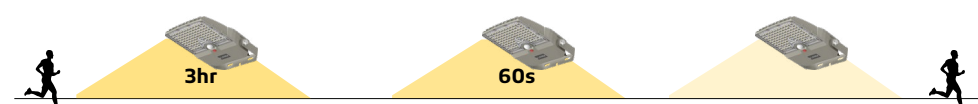

RST Light on 50% for 2 hours, then dims down to 20% for 6 hours, then dims down to 10% until dawn (Sensor disabled).

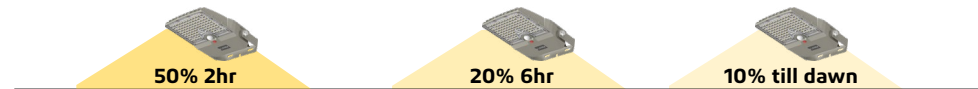

05 Panel Angle

The solar charge in a battery pack won't last forever. The off-grid system relies on stored solar energy for autonomy. Angling your solar panels properly can boost the power intake of your solar lighting system. You want to angle your solar panels at a tilt based on the area's latitude.

Tip

You can increase the tilt 15° in the winter or decrease 15° in the summer. In this way you can get the maximum sunlight to recharge the battery.

Key



Best Facing Direction of Solar Panel

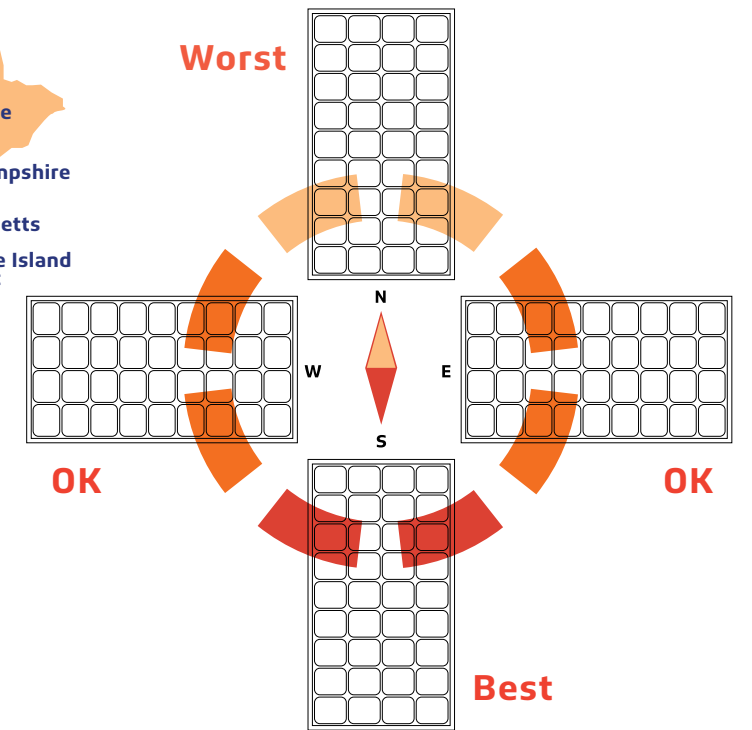

The area will dictate the installation of the fixtures and will sometimes prevent the lights from facing south. But that's okay! Panels facing West & East won't get as much light as Southern facing panels, but will still collect a good amount of sunlight. A North facing panel also works, but it will take longer to charge than any other direction. This would mean that the solar charge will be less optimal if installations are facing North.

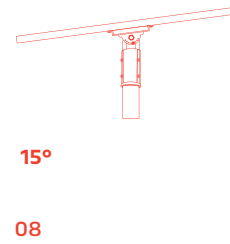
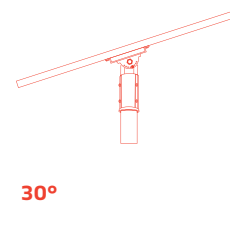
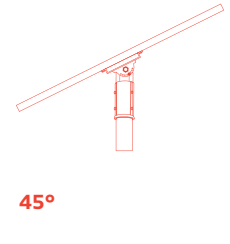
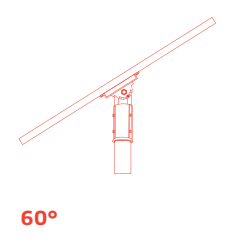
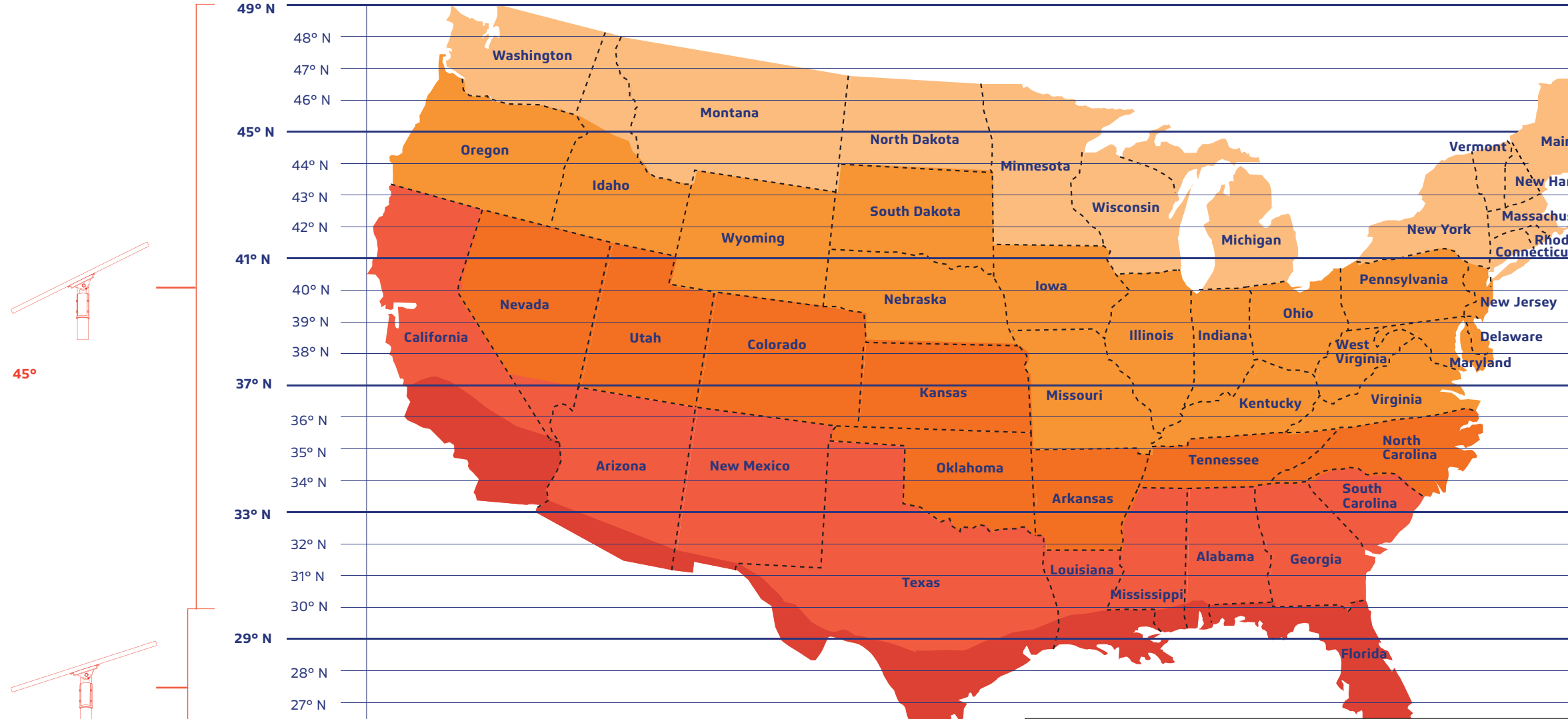
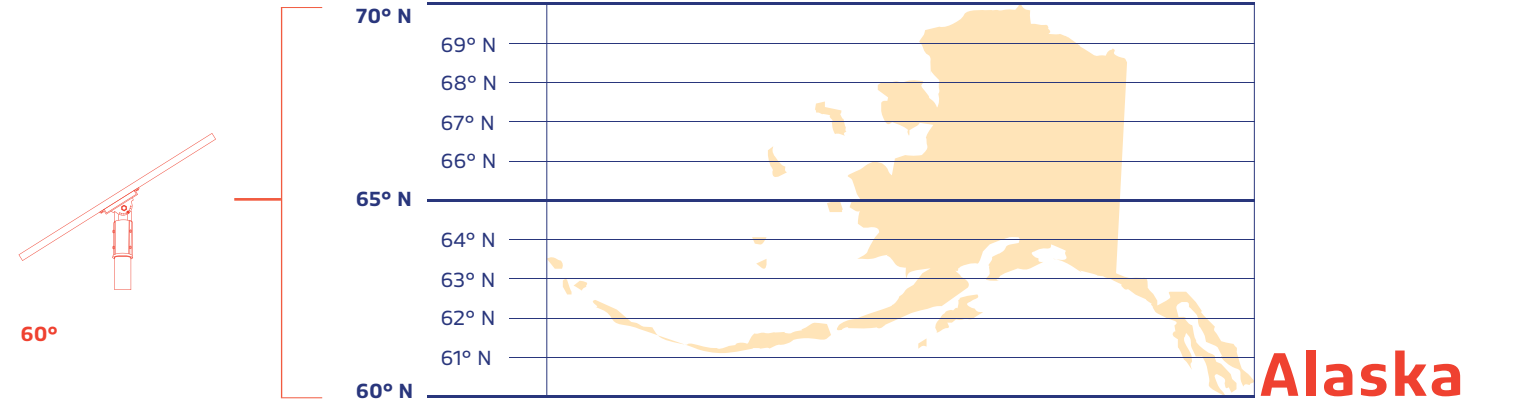

World Wide Panel Angles

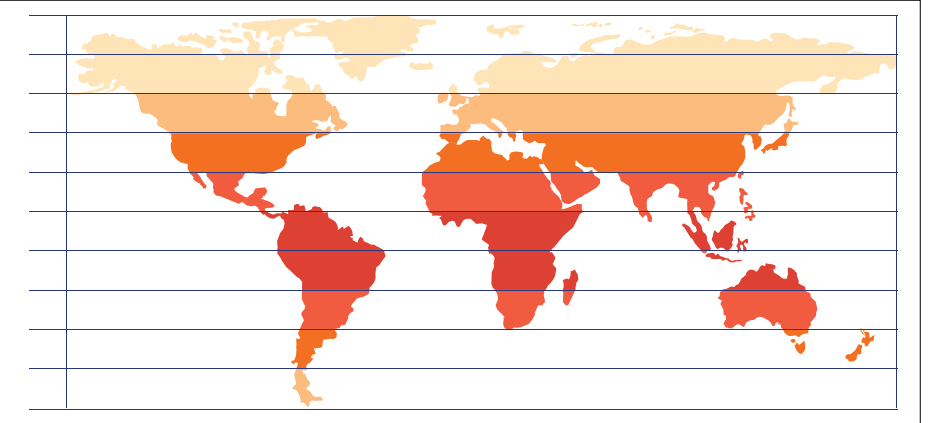
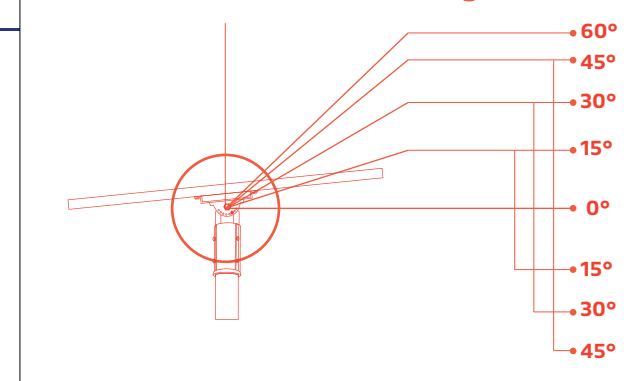

06 IES Light Distribution

FLUX 6W

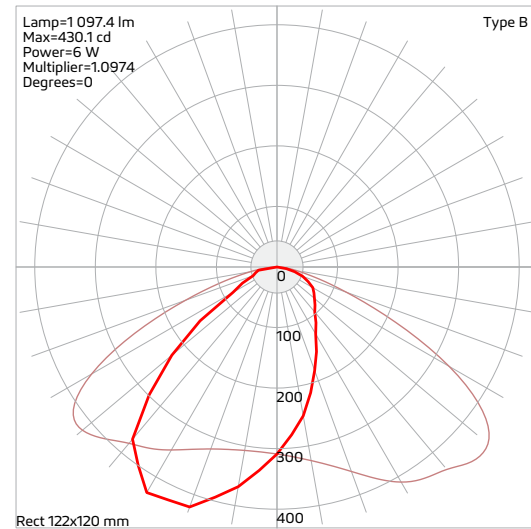

FLUX 20W

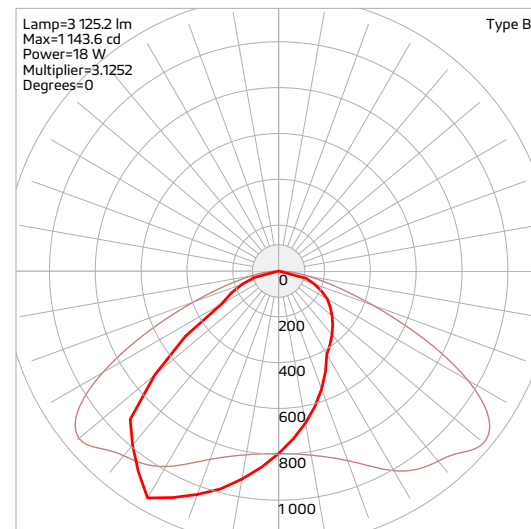

07 Warranty

FLUX is covered by a 3 year limited warranty. SOLTECH urban light warrants to the original purchaser that this product is free from defects in materials and workmanship for the period of 3 years from date of purchase. To obtain warranty service please contact your local distributor or sales rep for further instruction.

**SOLTECH Designs
and Manufactures
Advanced,
Solar-Powered
LED Technology.**



1460 Park Avenue.
Emeryville, CA 94608 USA
www.soltechlighting.com

SOLTECH LLC reserves the right to update all product data sheets at any time. Consult SOLTECH marketing specialists for publication updates at hello@soltechlighting.com

Copyright©2022-2023 SOLTECH LLC, All Rights Reserved.