



## FOCUS 10W 20W

### APPLICATIONS

SOLTECH solar signage lighting FOCUS has an all-in-one design and comes complete with a self-contained solar power assembly sized to run the specified solar light fixture. Install FOCUS at businesses, stores, schools and community signs. FOCUS will bring security and sustainability, with no electric bill and low maintenance costs.

### DESCRIPTION

FOCUS features an all-in-one design. The solar panel and battery are built with the hinged LED module as one complete system. There is no need for an extra power source, which eliminates the need for trenching, wiring, and electricity costs. Ideal for signage, billboards, landscaping, and architectural features. The fixtures will turn on at night, automatically, staying at 100% power for 4 hours (highest activity period) and then they dim down to 25%, for the rest of the night. FOCUS will bring security and sustainability with no electric bill and low maintenance costs.

CATALOG		COMMENTS
PROJECT		
PREPARED BY		
DATE		

### CERTIFICATION DATA



### ORDERING INFORMATION

SERIES	WATTAGE	COLOR TEMPERATURE	MOUNTING OPTIONS	SIZE
STL-JUP=FOCUS	10=10W 1000 Lumens 20=20W 2000 Lumens	4=4000K 5=5000K	ST=GROUND MOUNT	13=13 INCHES 26=20 INCHES

-  -  -  -

### SPECIFICATION FEATURES



#### Generates More Solar Energy

- Crystalline Solar Panel with 45 degree tilted angle design. Produces double the energy compared to horizontal panels
- Built-in tempered glass solar panel, designed to offer self-cleaning operation between rainy and sunny days



#### Longer Life

- LED life 50000 hours
- Easy to change modular battery pack for further extend product life
- Integrated Smart controller provides true dusk to dawn operation, with first 4-hours at full brightness, followed by 25% until dawn



#### Adjustable LED Module Design

- The hinged LED module with solar panel is adjustable to aim at the target object
- The solar panel blocks most glare for observer eye comfort



#### Heavy Duty and Flexible Base Design

- A commercial-grade steel base adjusts the height of the telescopic mount to ensure the fixture is at the right illumination height



# FOCUS 10W 20W

## PRODUCT SIZE

### FOCUS 10W

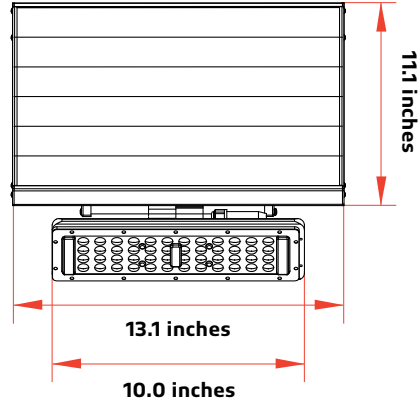
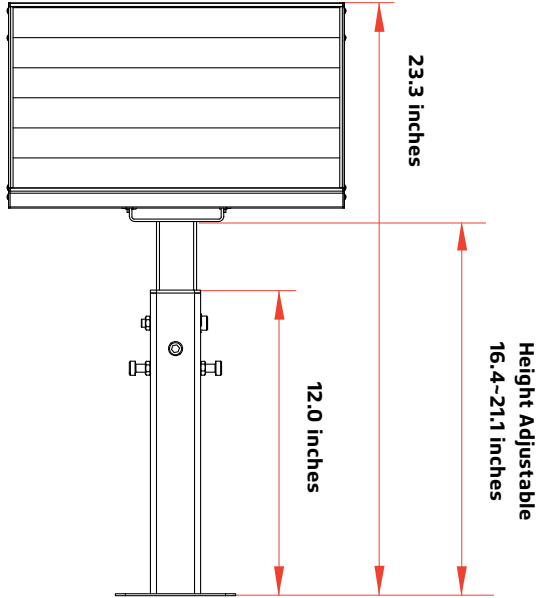

### FOCUS 20W

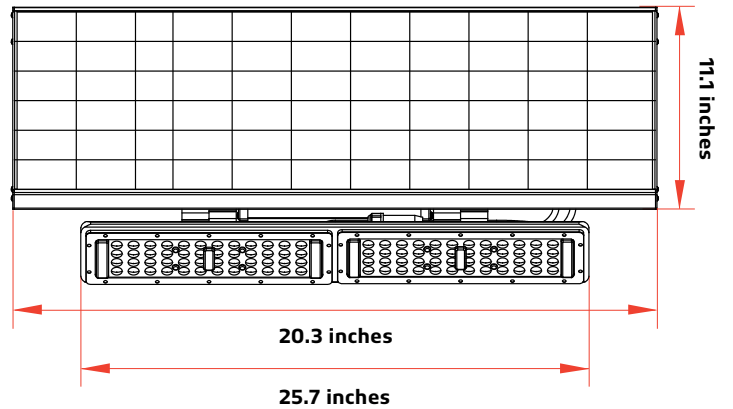
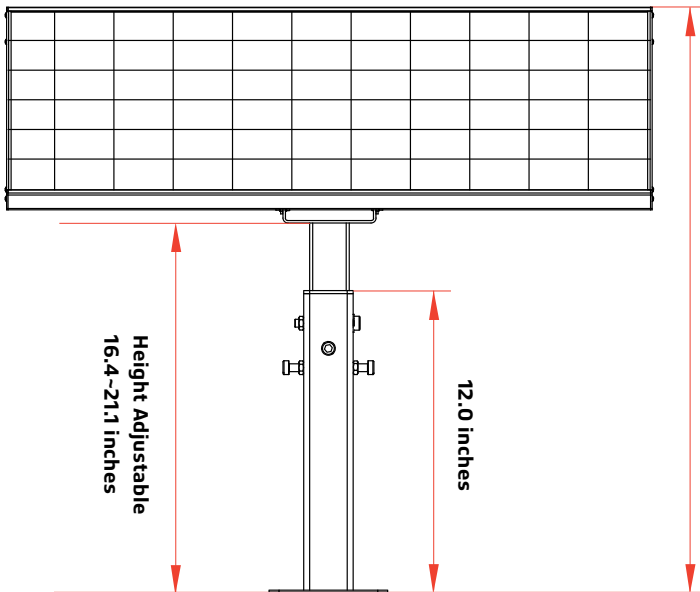

CATALOG		COMMENTS
PROJECT		
PREPARED BY		
DATE		



## FOCUS 10W 20W

CATALOG		COMMENTS
PROJECT		
PREPARED BY		
DATE		

### SPECIFICATIONS

<b>LED Nominal Power</b>	10W	20W
<b>Solar Panel</b>	12V 13W	12V 26W
<b>Lithium Ion Battery</b>	74WH 7.4V 10AH	148WH 7.4V 20AH
<b>CCT</b>	4,000K & 5,000K	4,000K & 5,000K
<b>Lumen Output@5000K</b>	1,000	2,000
<b>CRI</b>	> 70	> 70
<b>LED Chip</b>	OSRAM	OSRAM
<b>Beam Angle</b>	50° X 80°	50° X 80°
<b>Waterproof Rate</b>	IP65	IP65
<b>Casting</b>	PC & Aluminum	PC & Aluminum
<b>Efficiency@5000K</b>	100 lm/W	100 lm/W
<b>* Charging Time</b>	8-10hrs (1000W/m <sup>2</sup> )	8-10hrs (1000W/m <sup>2</sup> )
<b>Run Time (@Full Power)</b>	2-3 Days	2-3 Days
<b>Operation Mode</b>	First 4 hours 100% brightness, 25% brightness till dawn	First 4 hours 100% brightness, 25% brightness till dawn
<b>* Operating Temperature</b>	-4 °F to 149 °F	-4 °F to 149 °F
<b>* Charging Temperature</b>	32 °F to 113°F	32 °F to 113°F

\* The temperature can impact the battery's charging and normal operation.

\* The solar charge time data is base on 77 degree F ambient temperature with the panel pointed directly at the solar radiation. The standard radiation value is 1000W/m<sup>2</sup>.

**FOCUS 10W 20W**

CATALOG		COMMENTS
PROJECT		
PREPARED BY		
DATE		

**IES / BEAM**

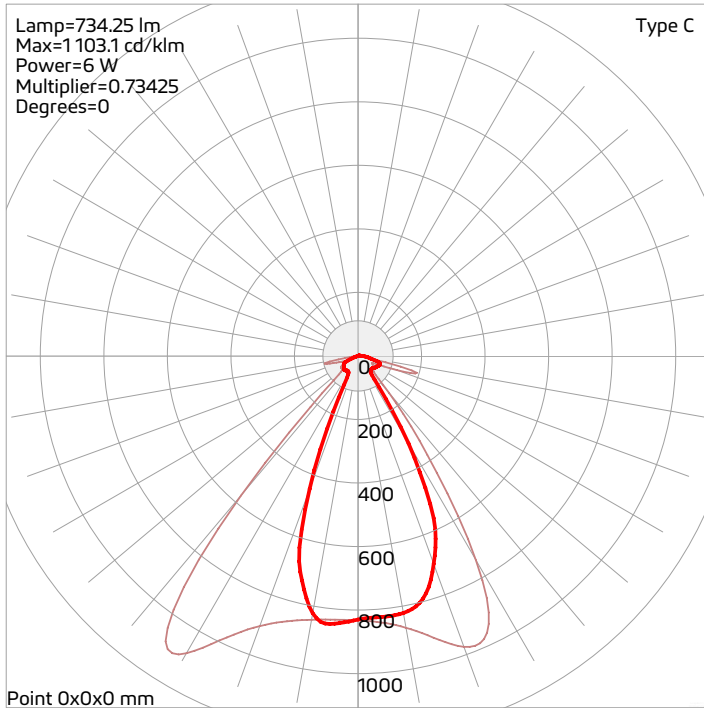

**FOCUS 10W**

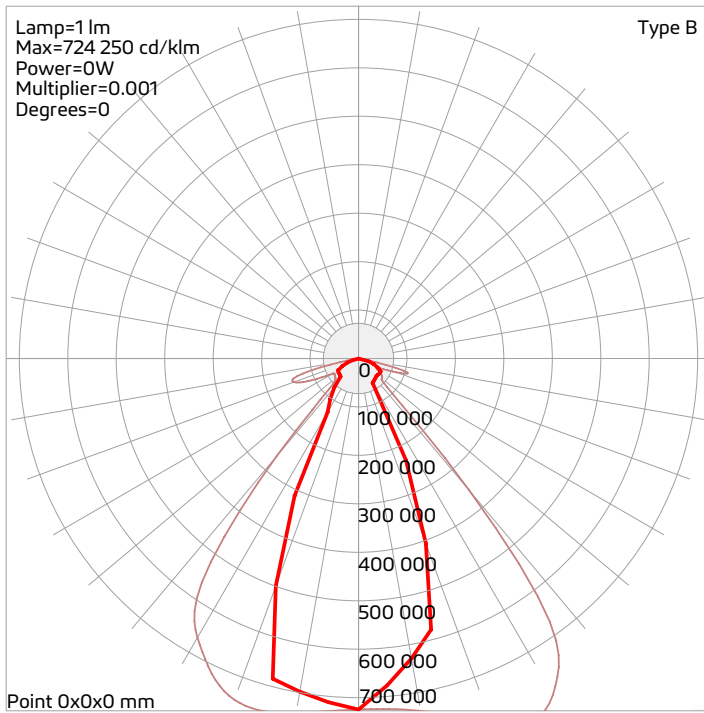

**FOCUS 20W**

CATALOG		COMMENTS
PROJECT		
PREPARED BY		
DATE		

**INSTALLATION**

01

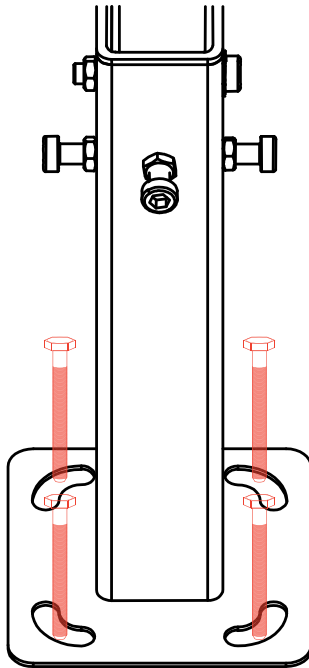

**Secure Mounting**

For signage near the ground, the FOCUS can use a drill installation into concrete, to create a secure, tightly bolted fixture.

02

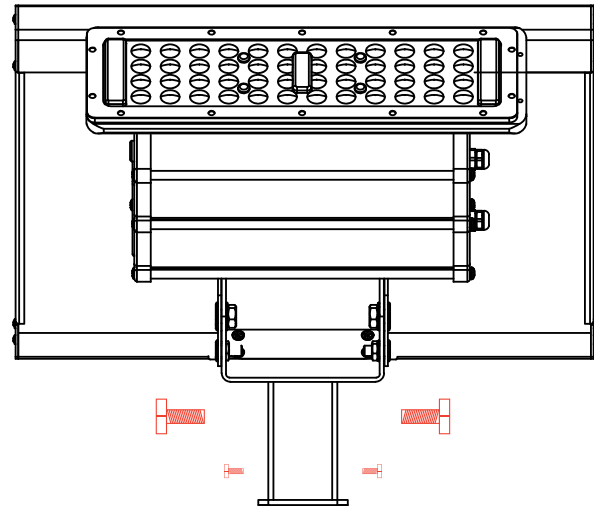

**Attach light by using scale holes**

03

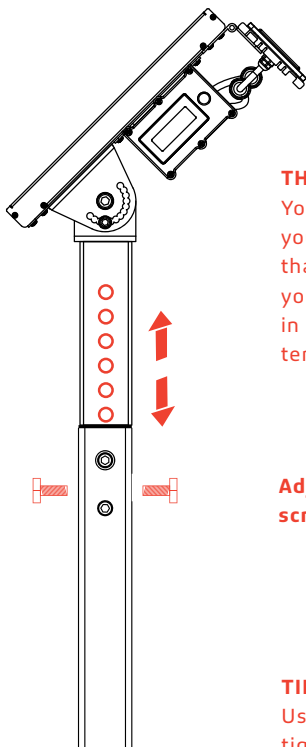

**THE RIGHT ANGLE**

You can adjust the angles of your FOCUS solar light, ensuring that no matter the installation, you can provide a right angle in different weather, signs, or temperature situations.

**Adjust pole height, then tighten screws to position.**

**TIP**

Use one bolt to set height, then tighten rest of the screws.

04

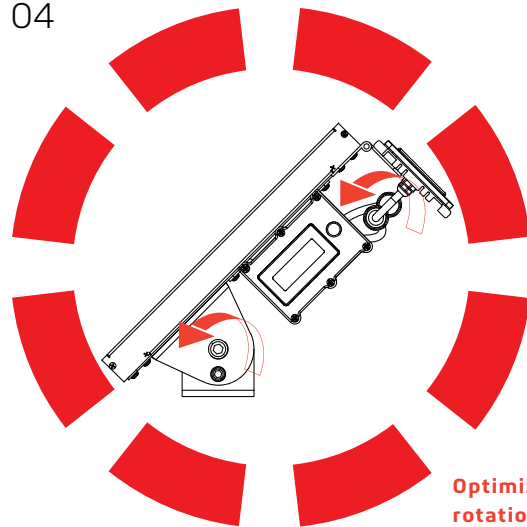

**Optimize efficiency by rotation Panel and Light**



# FOCUS 10W 20W

CATALOG		COMMENTS
PROJECT		
PREPARED BY		
DATE		

### WARRANTY

**FOCUS products are covered by a 3 year limited warranty. FOCUS urban light warrants to the original purchaser that this product is free from defects in materials and workmanship for the period of 3 years from date of purchase. To obtain warranty service please contact your local distributor or sales rep for further instruction.**



1460 Park Avenue.  
Emeryville CA 94608 USA

[www.soltechlighting.com](http://www.soltechlighting.com)

*SOLTECH LLC reserves the right to update all product data sheets at any time. Consult SOLTECH marketing specialists for publication updates at [hello@soltechlighting.com](mailto:hello@soltechlighting.com)*

*Copyright©20120-2021 SOLTECH LLC,  
All Rights Reserved.*